

# WING COMMANDER

THE PRICE OF FREEDOM



BASED ON THE MESH

AND TEXTURES

BY XWA TEAM & TOLWYN

AT [WCMD.F.SOLSECTOR.NET](http://WCMD.F.SOLSECTOR.NET)

BLACK LANCE DRAGON HEAVY FIGHTER

BY THUNDERCHILD

A

Mountain Fold: ——— or: - - - - -

Valley Fold: ——— or: - - - - -

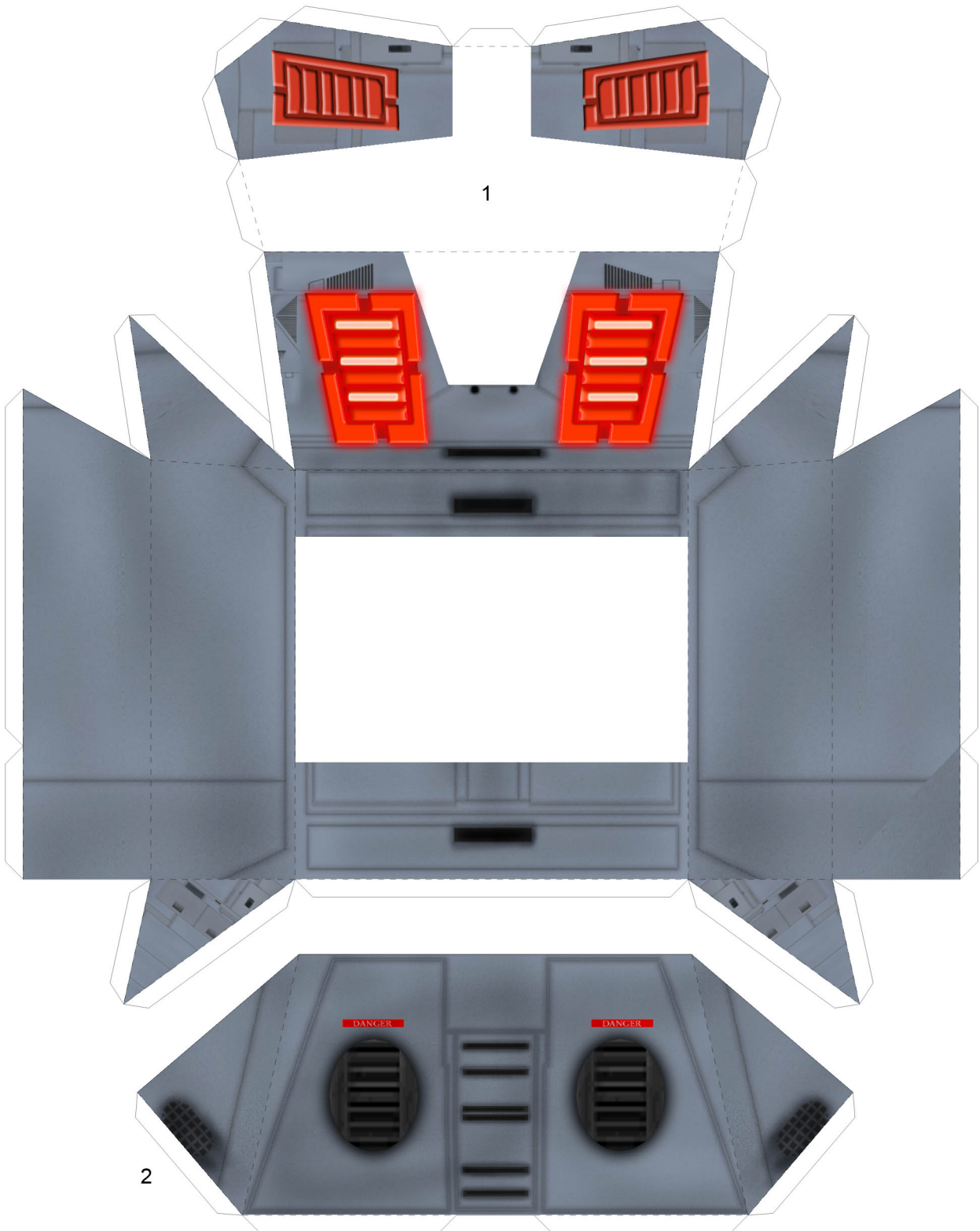

3

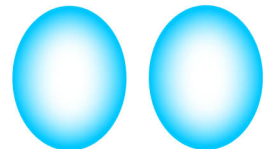

3 (Alternate)

B

Mountain Fold: — or: - - - -

Valley Fold: — or: - - - -

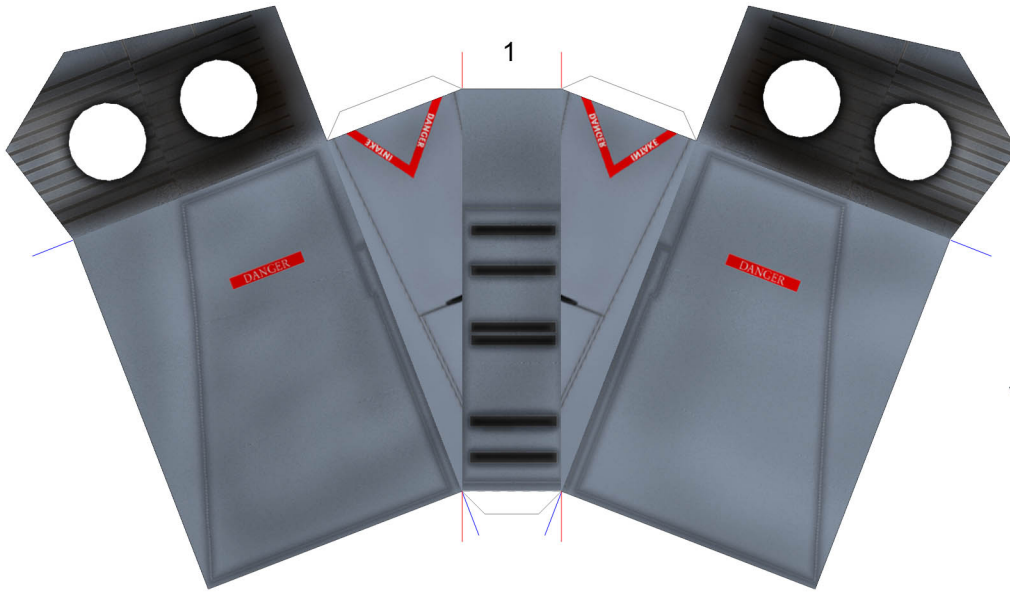

2

4

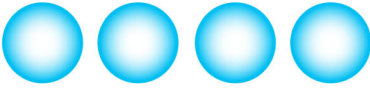

4 (Alternate)

3

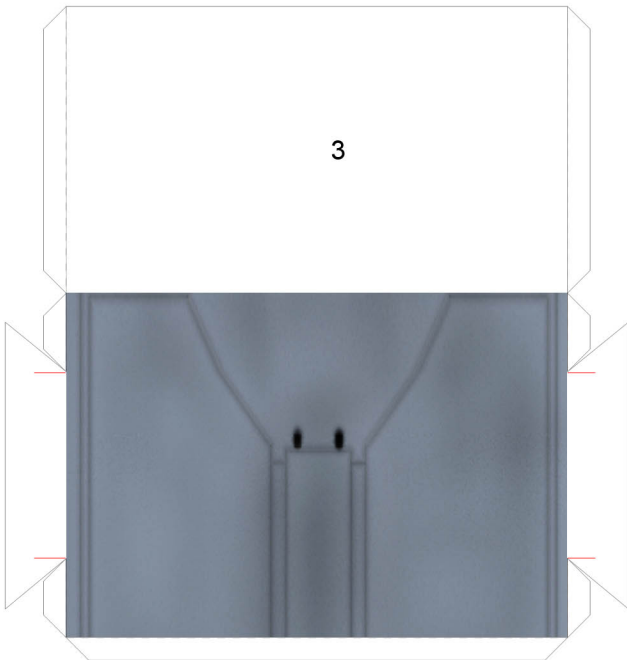

C

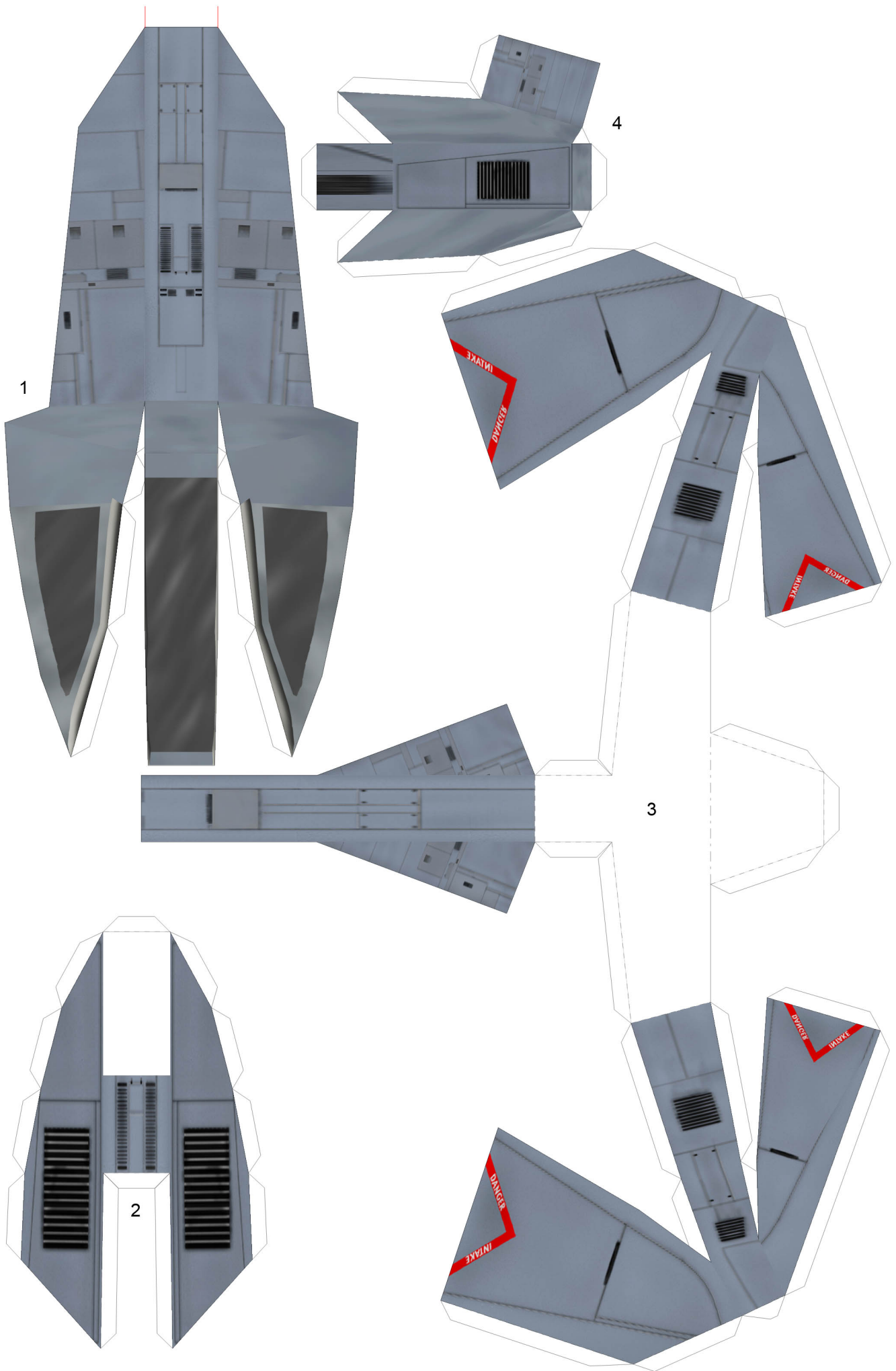

Mountain Fold:  or: 

Valley Fold:  or: 

D (Left Wing)

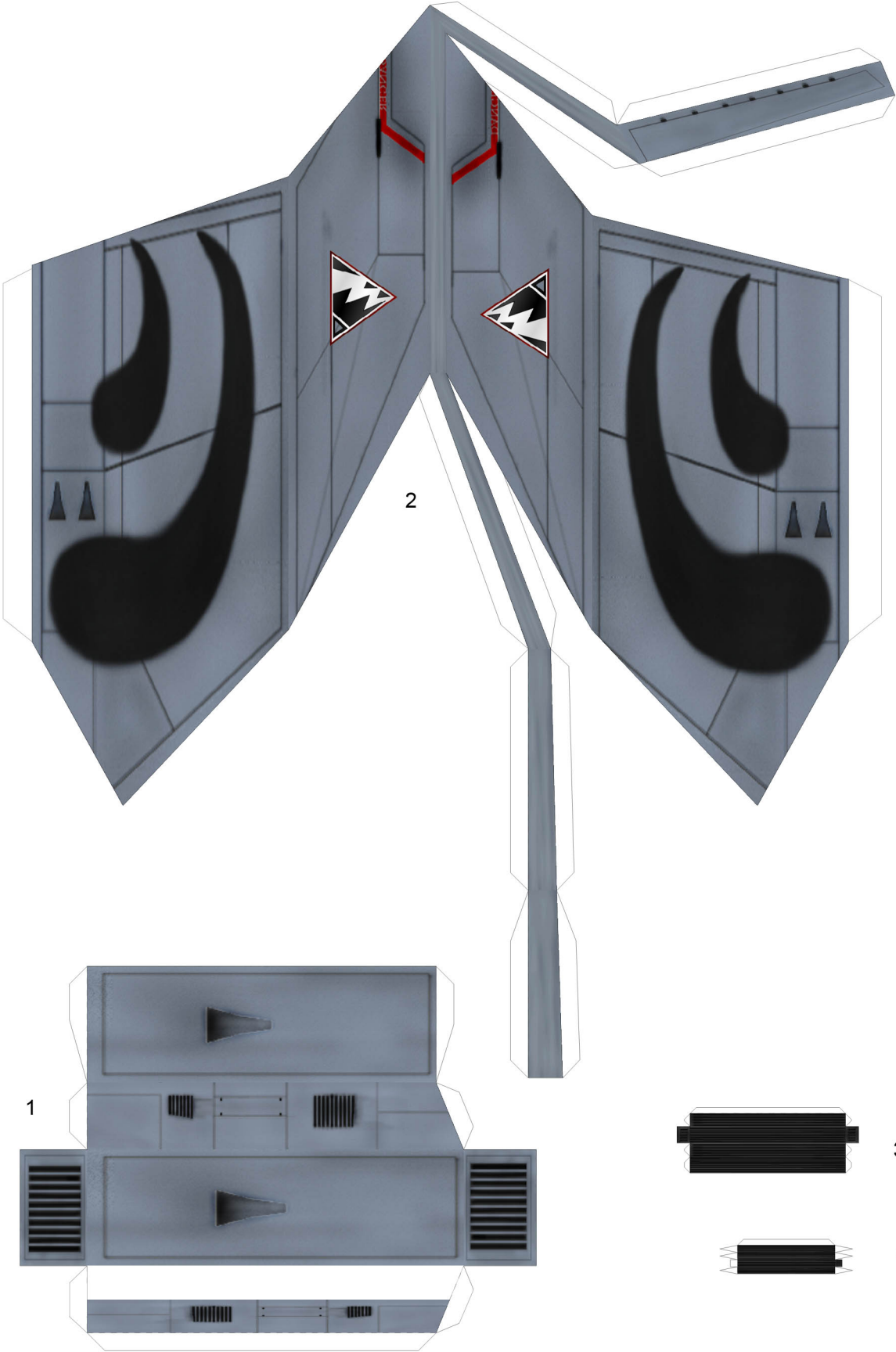

D (Right Wing)

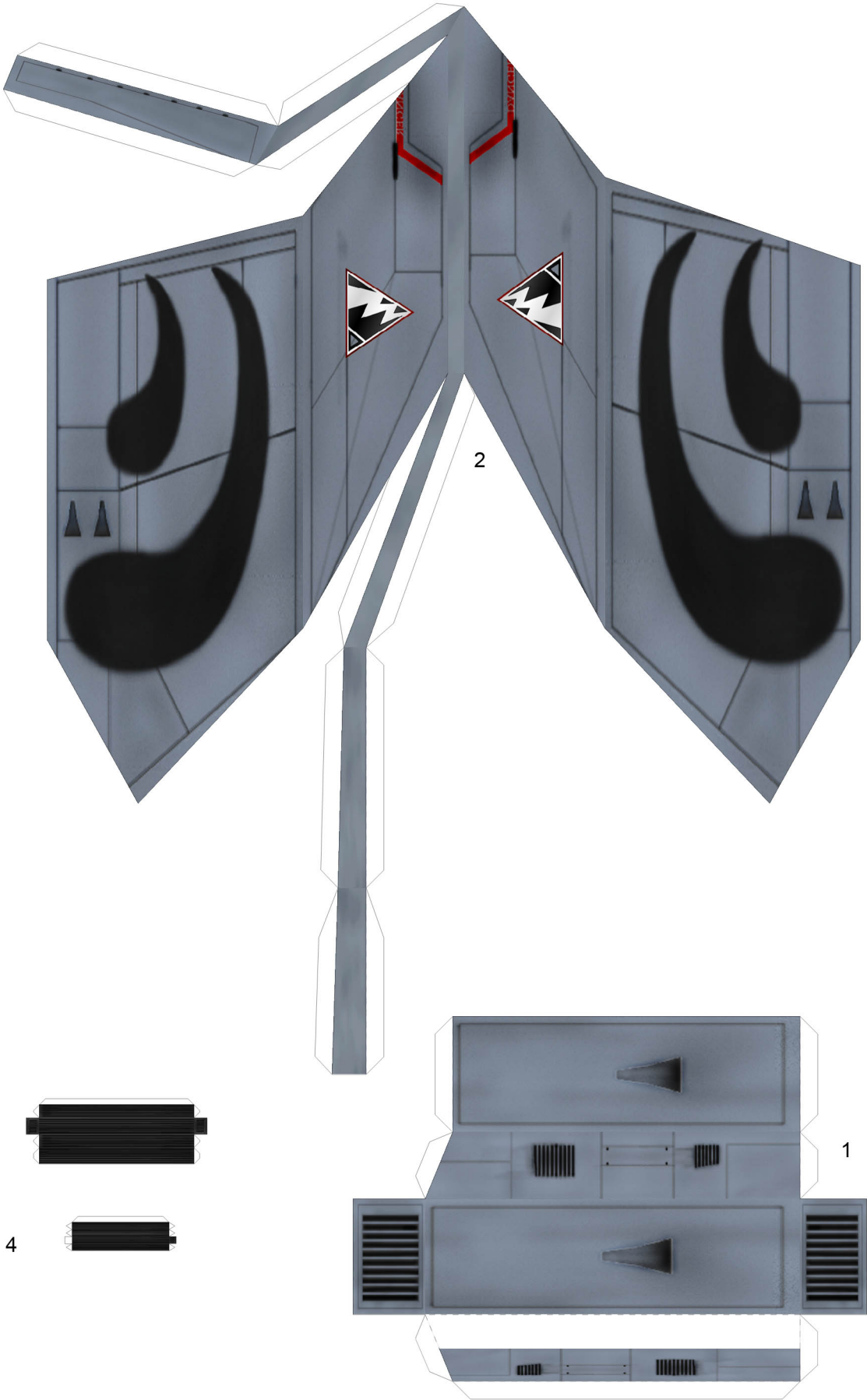

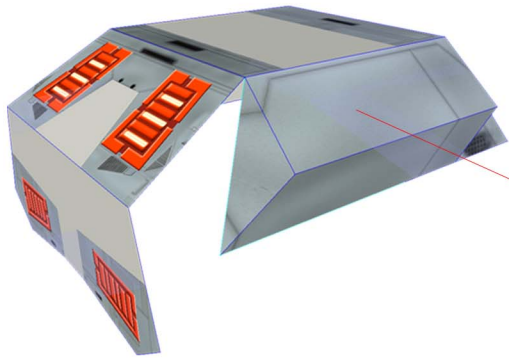

A1

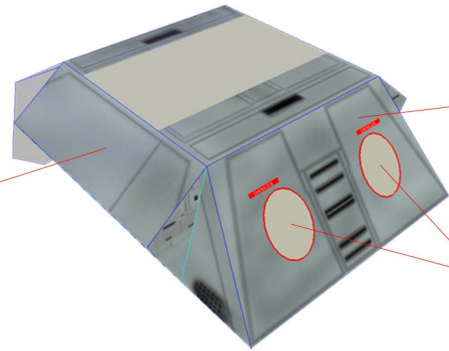

A2

A3

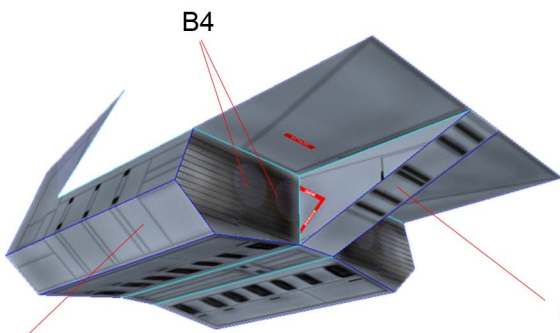

B4

B1

B2

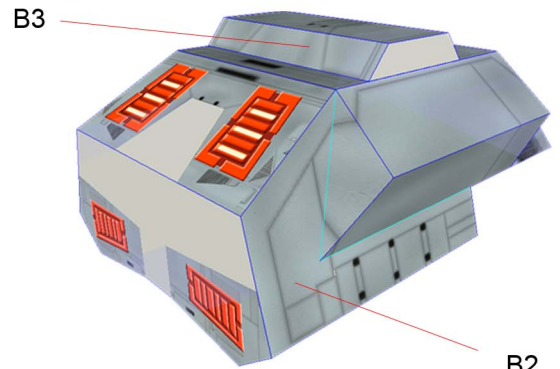

B3

B2

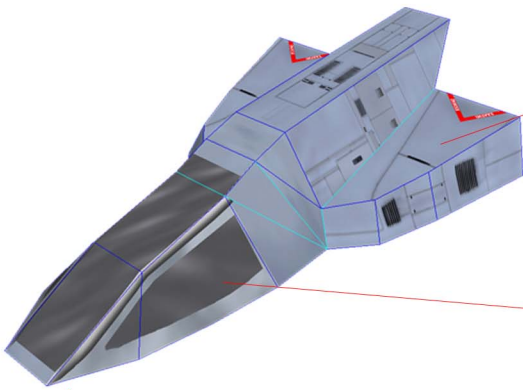

C3

C1

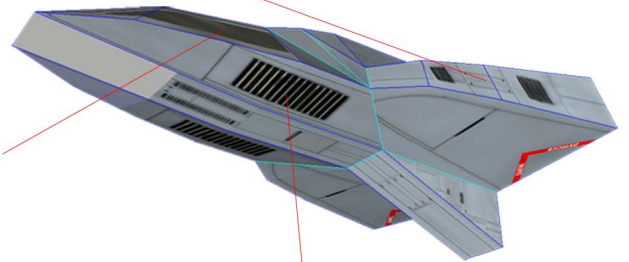

C2

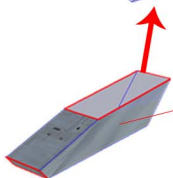

C4

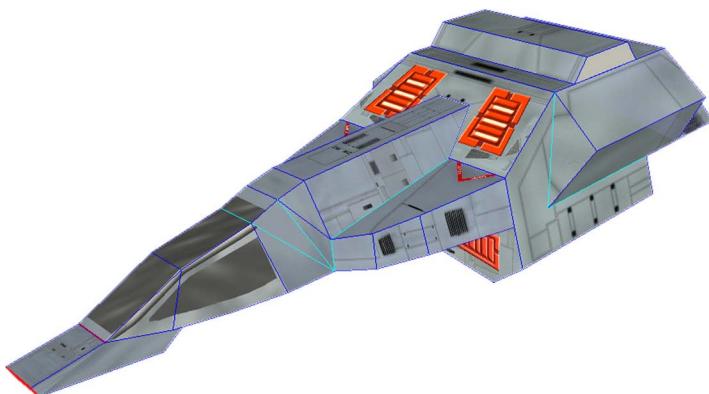

D1

D2

D3

D4

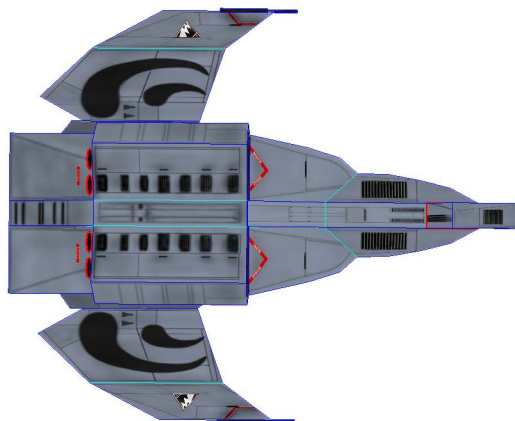
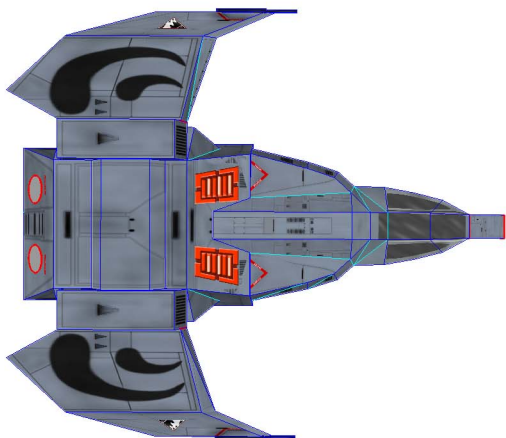
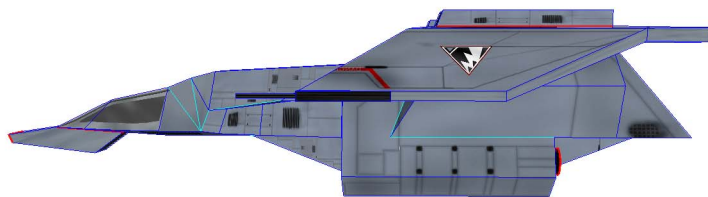
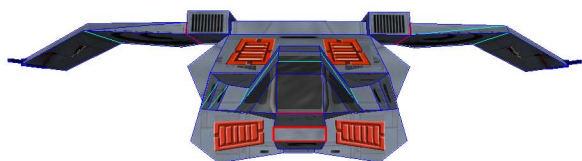
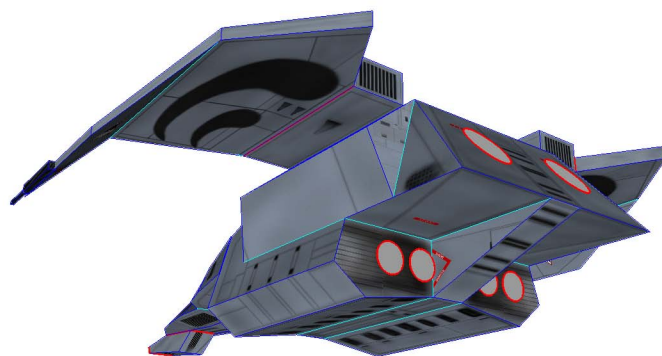
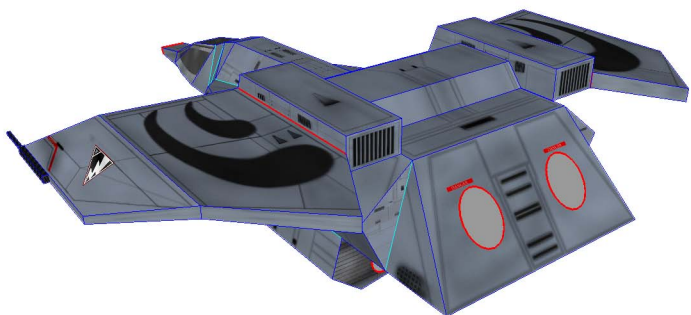
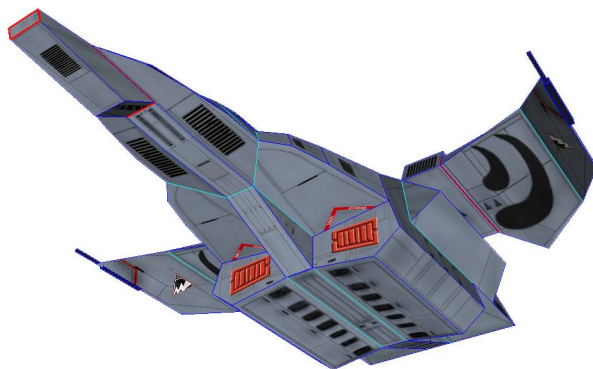
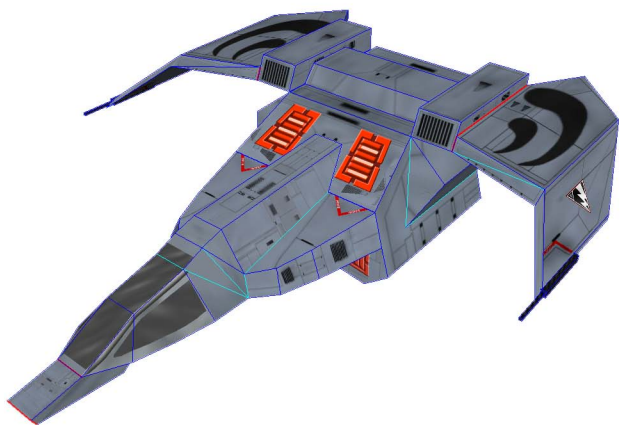

Based on the mesh and textures created by [XWA Team](#) (original model) and [Tolwyn](#) (conversion) at [wcmdf.solsector.net](http://wcmdf.solsector.net)

Paper Model created by ThunderChild (thunderchild\_pdp@yahoo.com)  
This model is provided free of charge and is **NOT** to be sold.